

Einteilig  
Single element

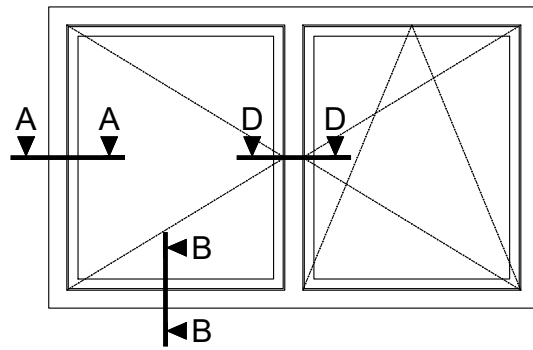

Zweiteilig mit Kämpfer  
Two-sash with mullion

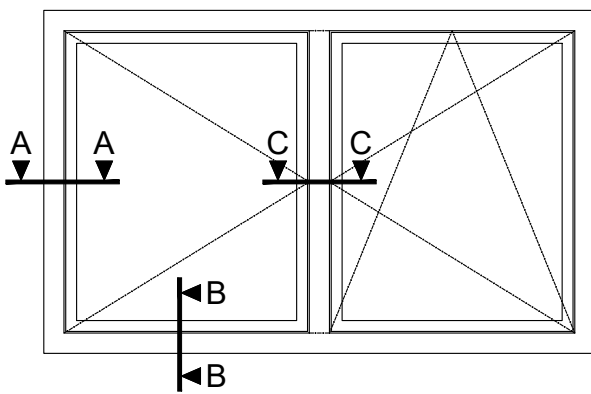

Zweiflügelig mit Stulp  
Two-sash with flying mullion

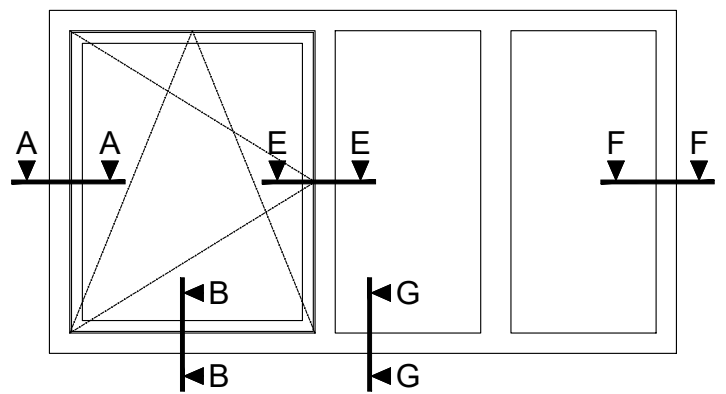

Dreiteilig mit zwei Fixfeldern  
Three parts with two fixed fields

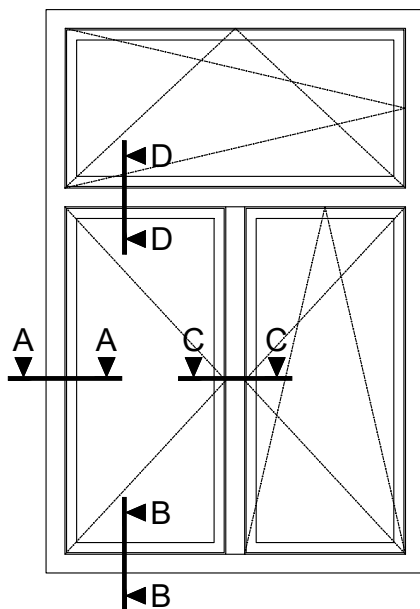

Zweiflügelig mit Oberlichte  
Two-sash with fanlight

KF310 Home Pure CR

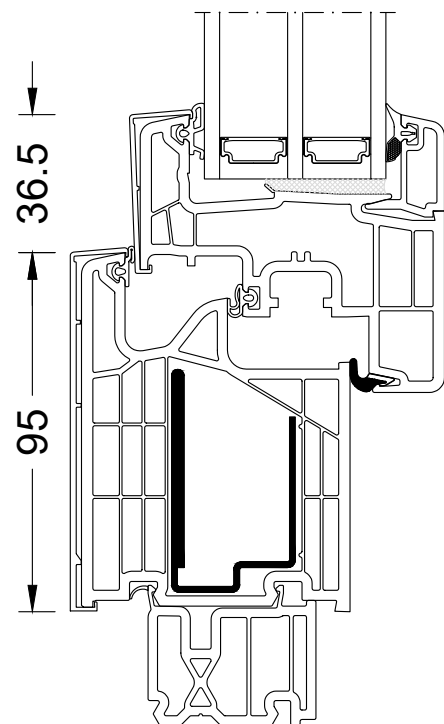

- BM Bestellmaß / Ordering size
- FM G Flügelmaß Gehflügel / Sash size master sash
- FM S Flügelmaß Stehflügel / Sash size slave sash
- FOK Fußbodenoberkante / Finished floor level
- GM Glasmaß / Glass size
- RA Rahmenaußenmaß / Outside frame size
- TM Teilungsmaß / Division size

- Schnitt / section I-I = Ausführung mit Bodenschwelle OEN  
Version with low threshold OEN
- Schnitt / section J-J = Ausführung mit Bodenschwelle DIN  
Version with low threshold DIN
- Schnitt / section K-K = Ausführung mit Bodenschwelle barrierefrei  
Version with threshold barrier-free

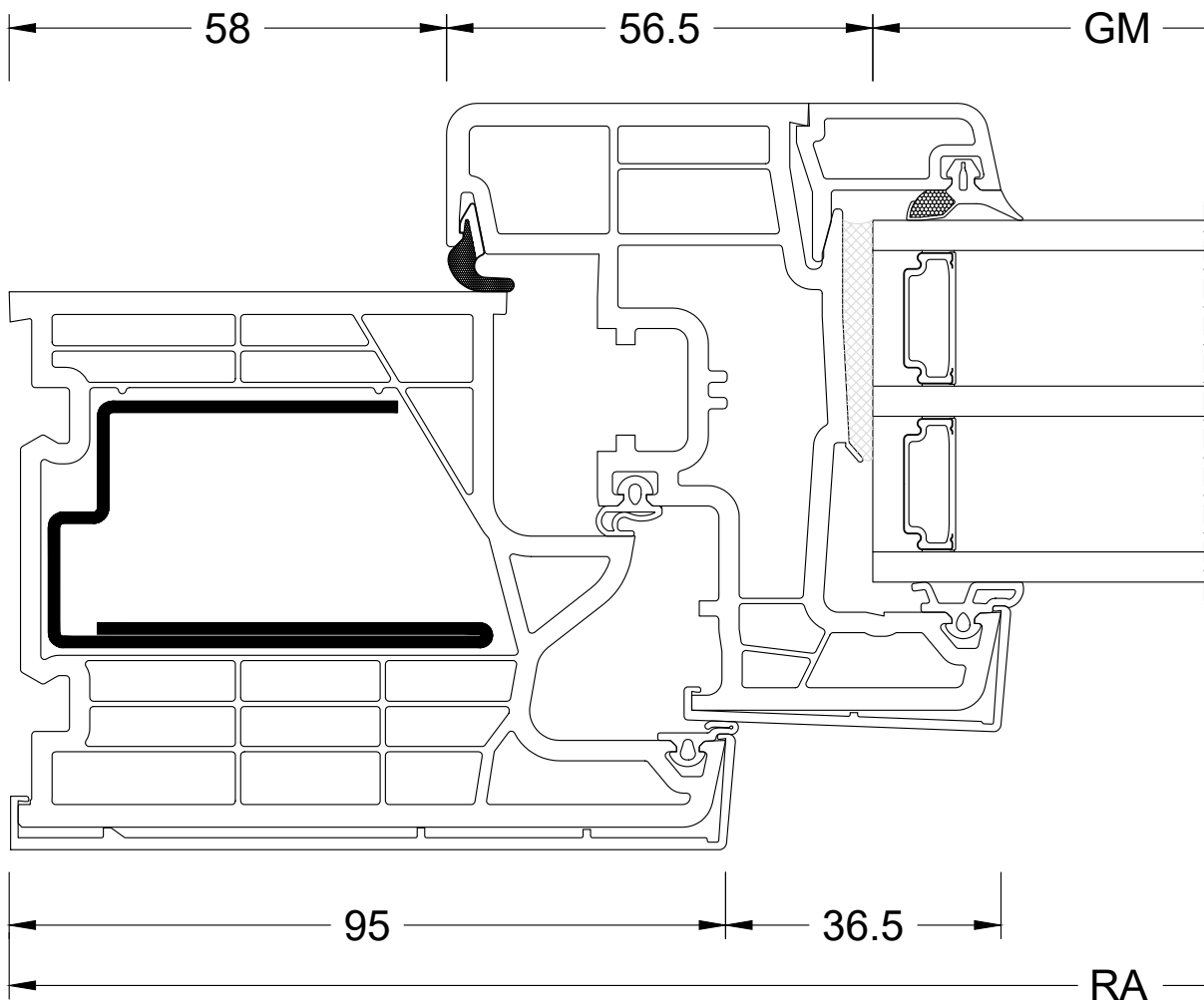

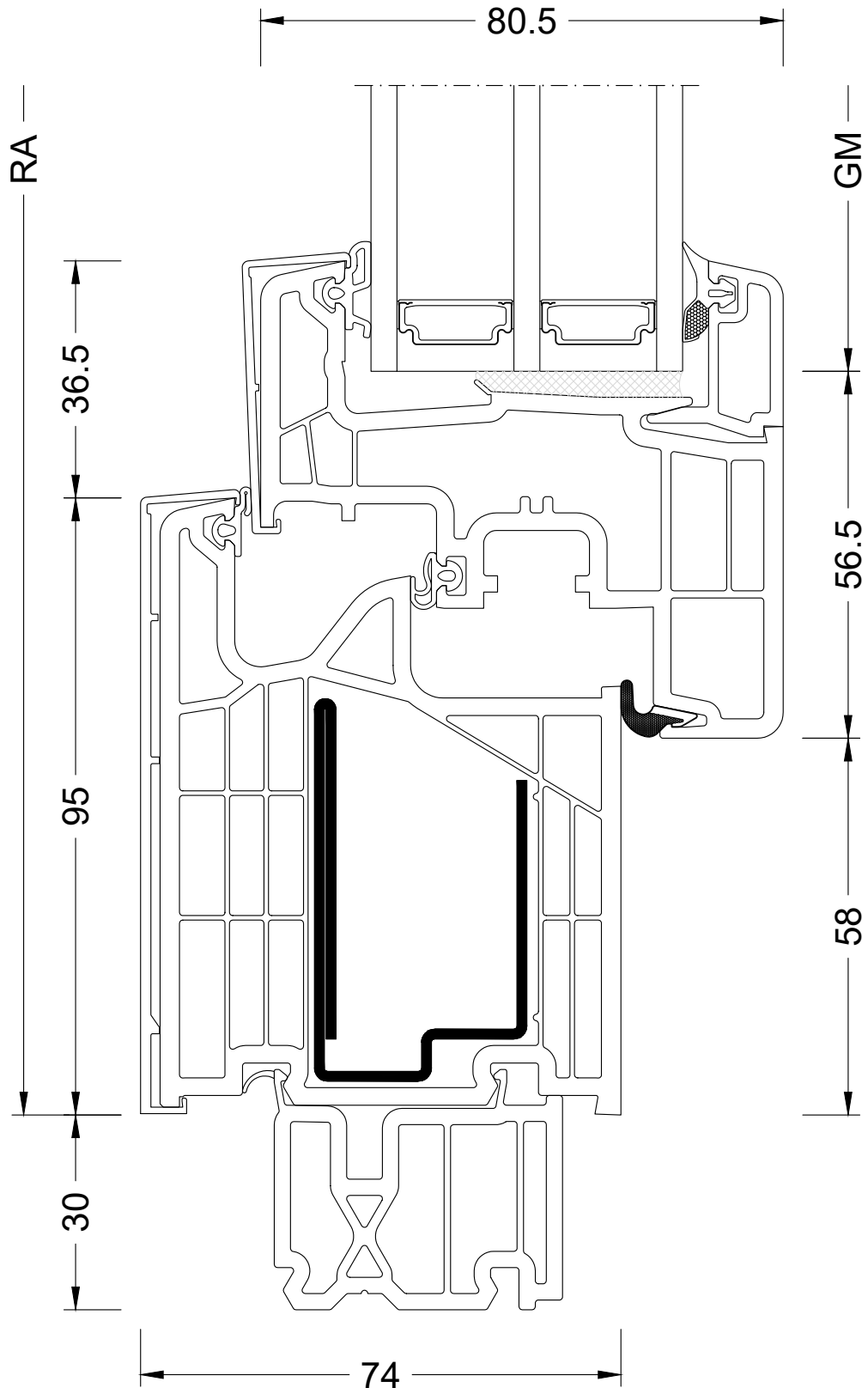

mit innerer Schlagleiste  
with internal cover strip

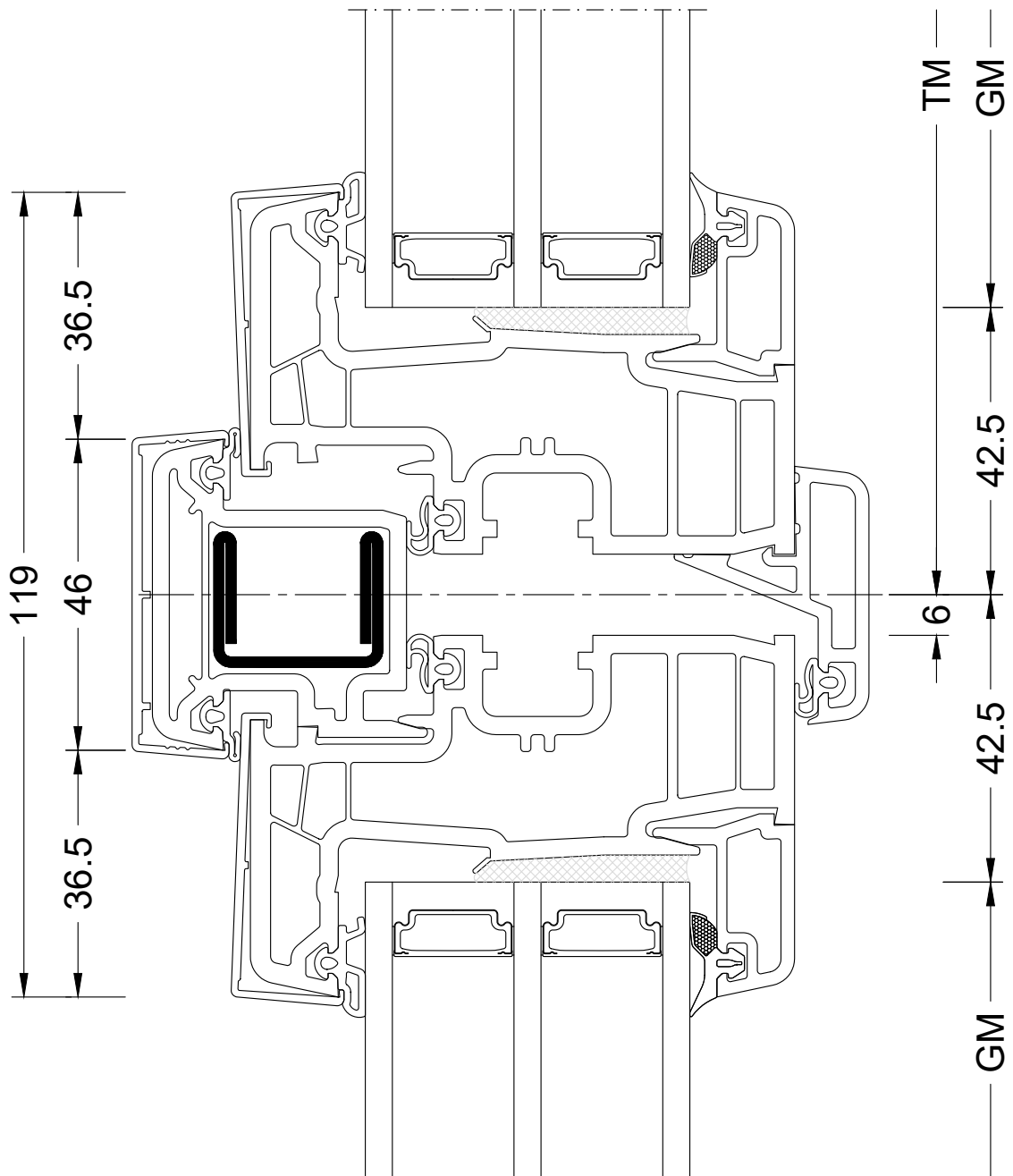

ohne innerer Schlagleiste  
without internal cover strip

