

Einteilig
Single element

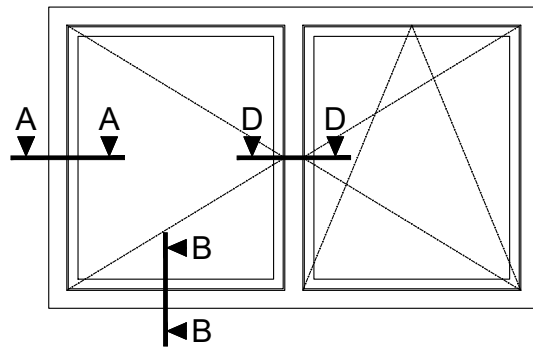

Zweiteilig mit Kämpfer
Two-sash with mullion

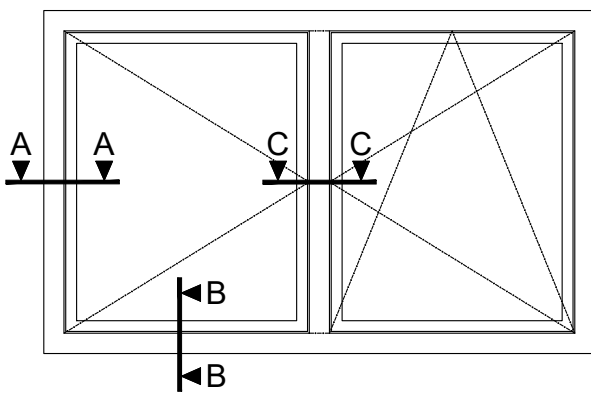

Zweiflügelig mit Stulp
Two-sash with flying mullion

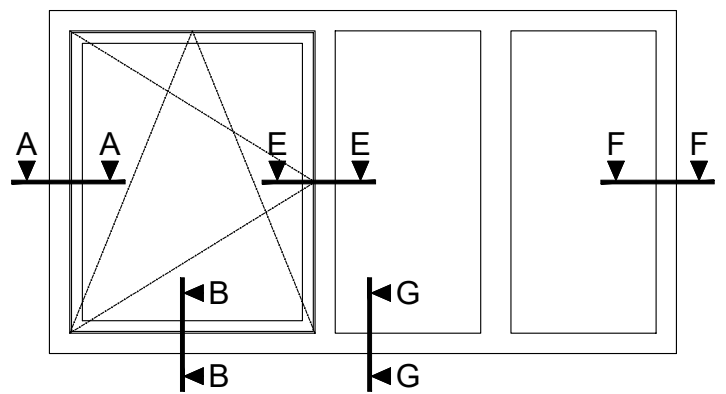

Dreiteilig mit zwei Fixfeldern
Three parts with two fixed fields

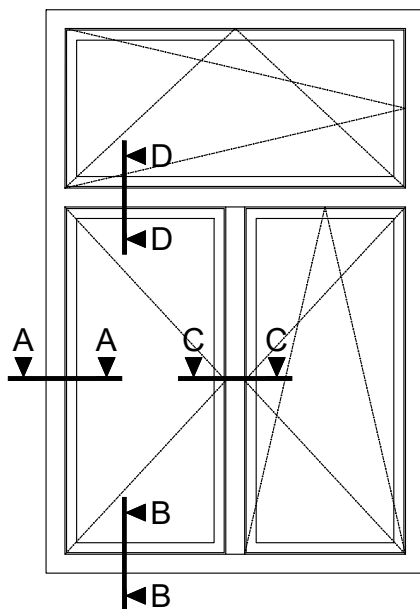

Zweiflügelig mit Oberlichte
Two-sash with fanlight

KF510 Home Pure CR

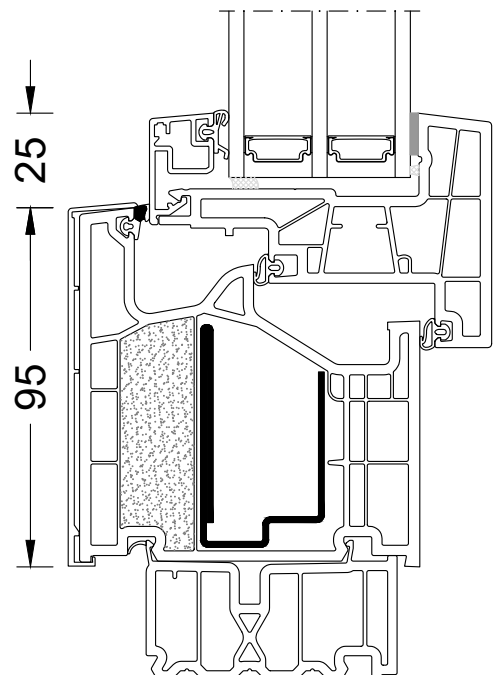

Schnitt / section I-I = Ausführung mit Schwelle 30 mm
Version with threshold 30 mm

Schnitt / section J-J = Ausführung mit Schwelle 25 mm
Version with threshold 25 mm

- BM Bestellmaß / Ordering size
- FM G Flügelmaß Gehflügel / Sash size master sash
- FM S Flügelmaß Stehflügel / Sash size slave sash
- FOK Fußbodenoberkante / Finished floor level
- GM Glasmaß / Glass size
- RA Rahmenaußenmaß / Outside frame size
- TM Teilungsmaß / Division size

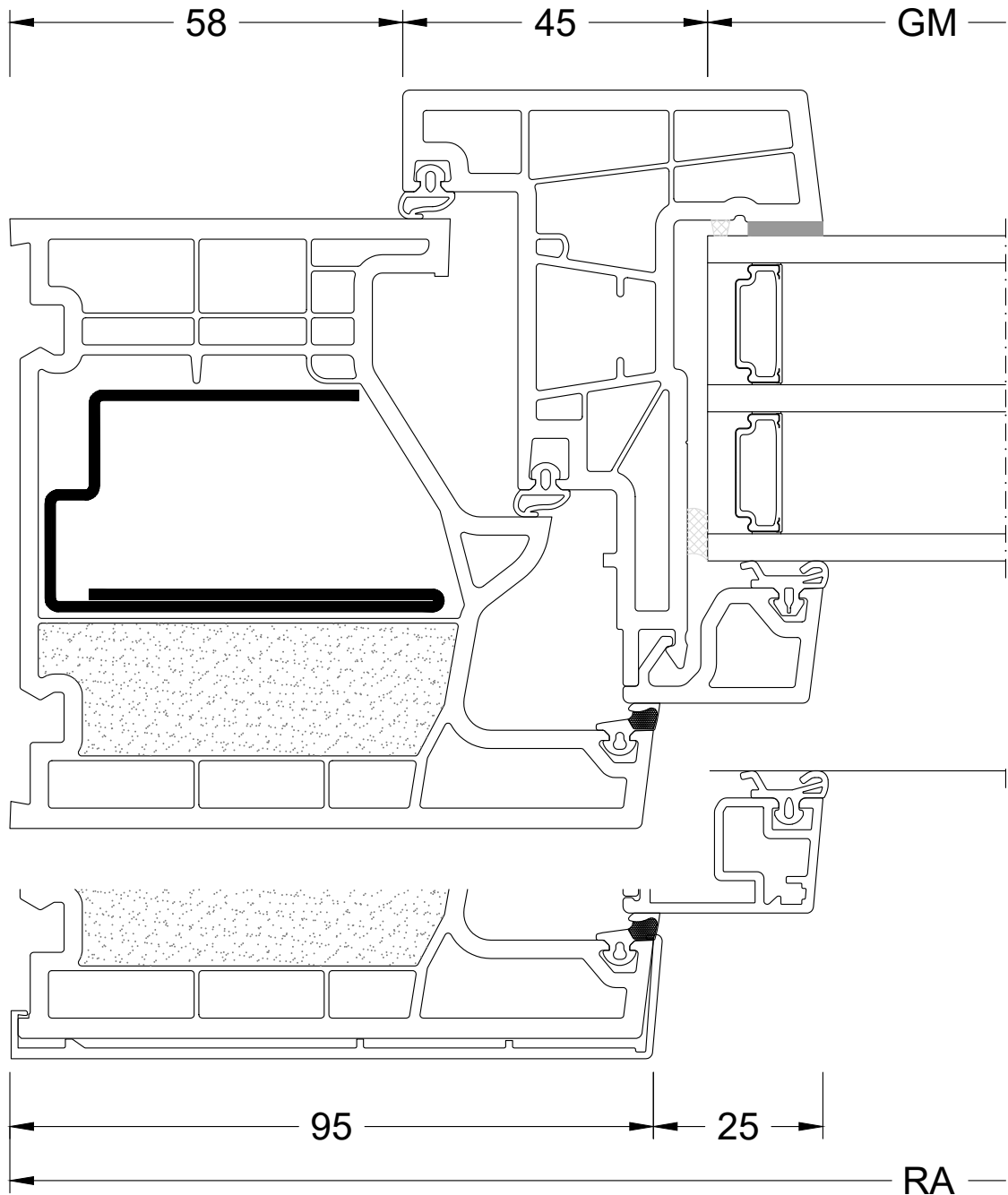

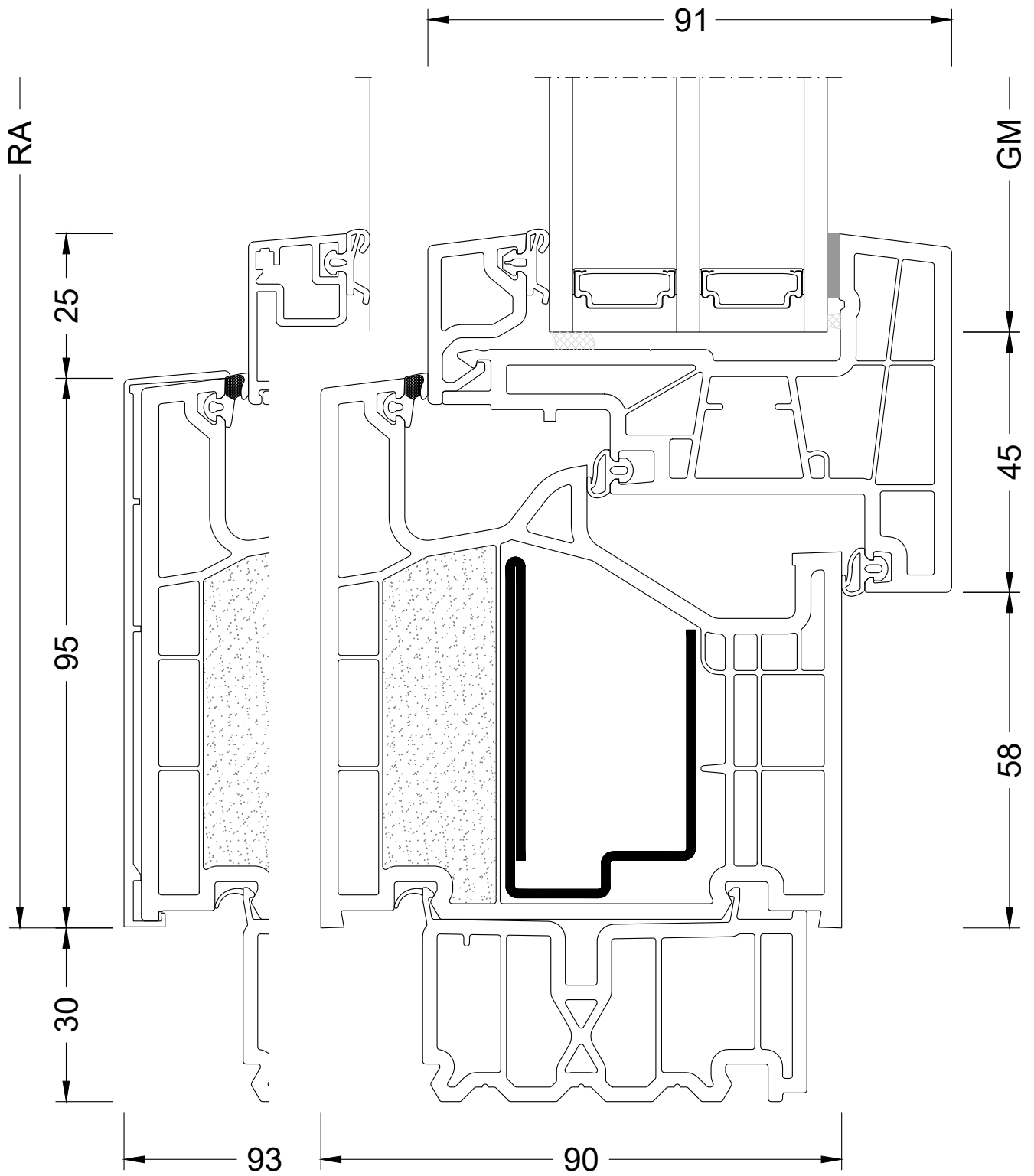

ohne innerer Schlagleiste
without internal cover strip

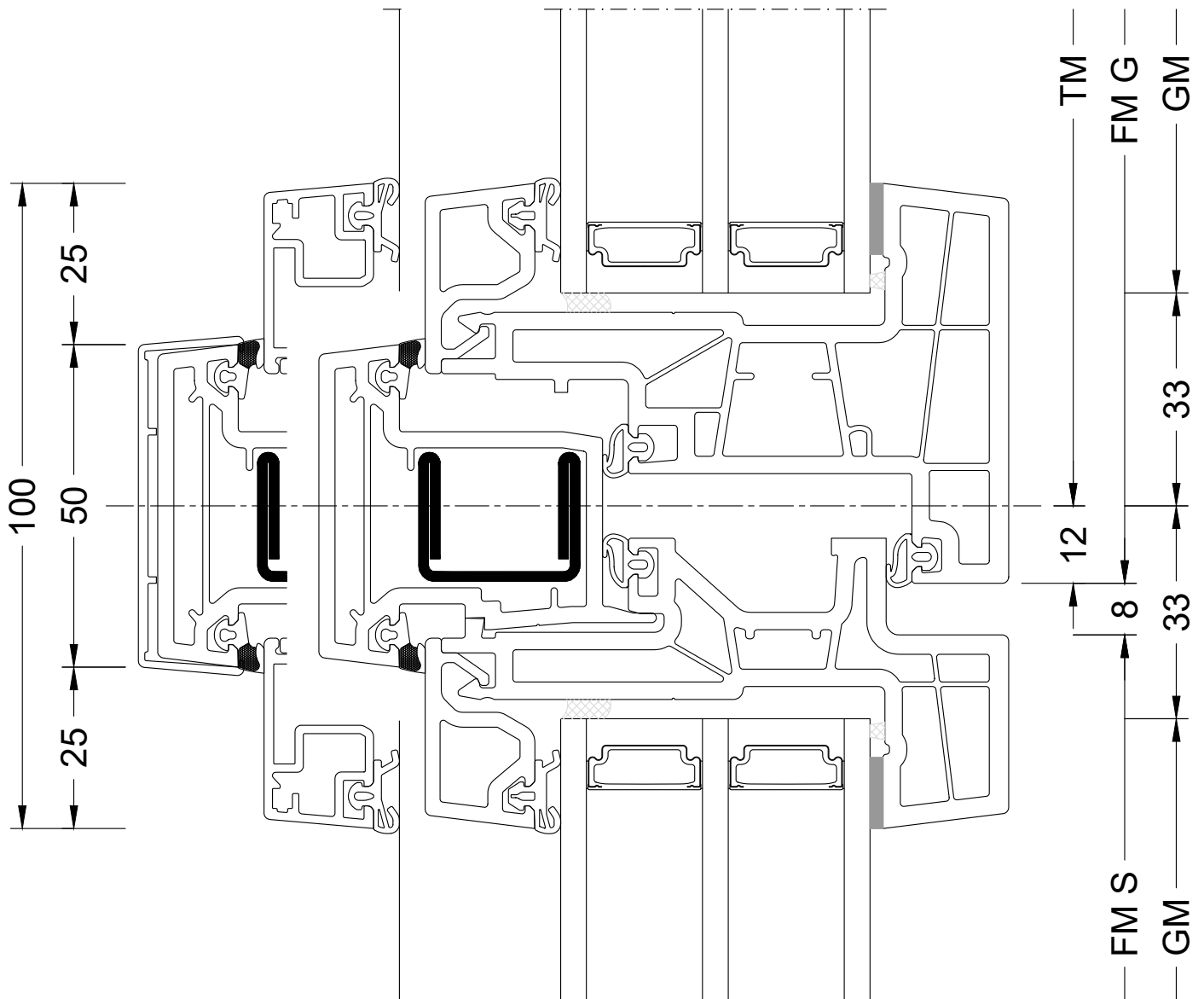

mit innerer Schlagleiste
with internal cover strip

